

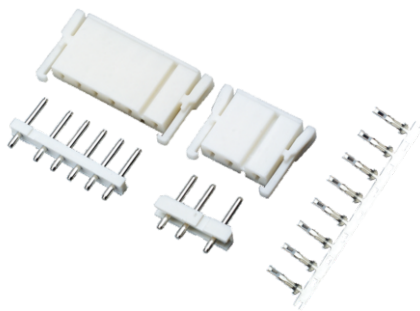

TJC2A 型条形连接器

TJC2A Bar Connector

间距 (space) : 7.5-5...5mm



技术参数 (Specifications)

适用线规 (Applicable wires) : AWG#26~AWG#20
 适应基板厚度 (Applicable PC board thickness) : 1.6mm
 温度范围 (Temperature range) : -25°C~85°C
 额定电压 (Voltage rating) : 250V AC/DC
 额定电流 (Current rating) : 3A
 接触电阻 (Contact resistance) : ≤10mΩ
 绝缘电阻 (Insulation resistance) : ≥1000MΩ
 耐压 (Withstand voltage) : 1500V AC/minute
 认证 (Standards) :  E200881

插簧 Contact

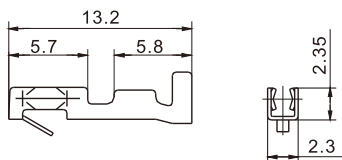

型号 Type	适用导线范围 Wire Range		导线外径 Wire ins.Dis
	mm ²	AWG#	
CH-TJC2	0.13~0.5	26~20	1.3~1.8
材质 · 表面处理 Material and Finish			
磷青铜 镀锡 Phos · bronze Tin · Plated			

孔座 Housing

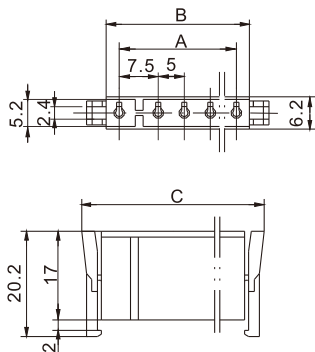

线数 Poles	型号 Type	尺寸Dimensions(mm)		
		A	B	C
2	TJC2A-2Y	7.5	12.5	20
3	TJC2A-3Y	12.5	17.5	25
4	TJC2A-4Y	17.5	22.5	30
5	TJC2A-5Y	22.5	27.5	35
6	TJC2A-6Y	27.5	32.5	40
材质 Material		PA66 UL94V-0		

TJC2A 型条形连接器

TJC2A Bar Connector

间距 (space) : 7.5–5...5mm

阳连接器 (立式, 直插) Header (V, DIP)

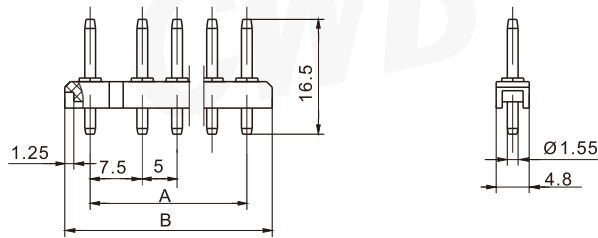

线数 Poles	型号 Type	尺寸Dimensions(mm)	
		A	B
2	TJC2A-2A	7.5	14.8
3	TJC2A-3A	12.5	19.8
4	TJC2A-4A	17.5	24.8
5	TJC2A-5A	22.5	29.8
6	TJC2A-6A	27.5	34.8
材质·表面处理 Material and Finish			
PBT UL94V-0; 黄铜 镀锡 Brass Tin·Plated			

安装尺寸 Mounting Measurement

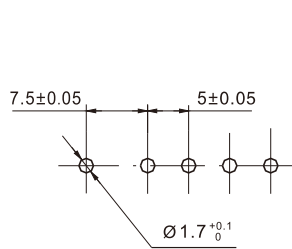

PCB Layout

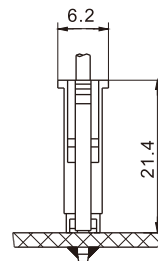

Assembly View (DIM FYI)